

Replacement
Styli

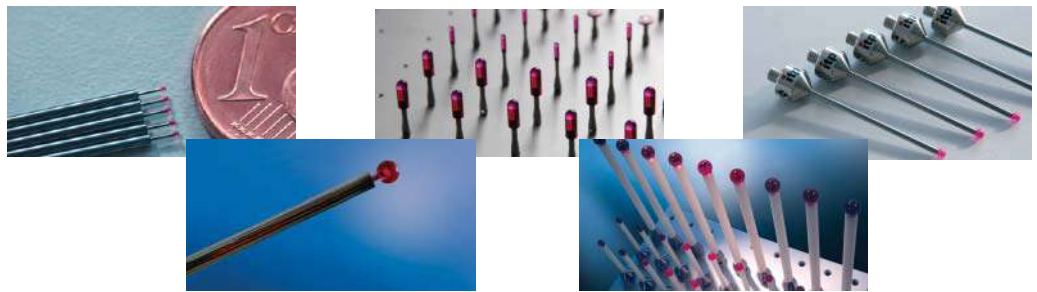

itpTM
styli



Adapter Plates and Adapter Plate Extensions

Adapter plates equivalent to Zeiss Vast and MT with active ID chip and individual plate code. Every plate is tested before shipping. Unbeatable price and ships same day.

Adapter plate extensions with or without cube offer integral components to maximize rigidity.



Temp-Comp: Constant Length at Varying Temperatures

Temp-Comp thermal stable carbon fiber provides relatively low weight and the greatest temperature stability. When coupled with our unique titanium end cap design, thermal expansion is essentially zero on a 180 mm long extension.



Custom Probe Tooling Solutions

Ask us about custom probe tooling solutions from design to delivery. Titanium holders with your unique angles are coupled with Temp-Comp thermal stable carbon fiber in rigid configurations designed to improve cycle time and measurement accuracy.

itp Specials: Custom Styli Manufactured to Your Specifications



Whether it is a simple change in length or a more elaborate customization, itpstyli welcomes the opportunity to provide the solution you need.



Best Quality

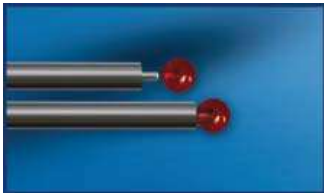

Peg mounted ruby spheres drilled in-house increase durability and accuracy on spheres up to 10mm in diameter. (Below 0.5mm, drilling is not possible)

Visit us at itpstyli.com



Search by other manufacturer code or use the unique search filters to find what you need. Save your shopping list. View previous orders. And more.



Table of Contents

Click on the description to jump to that page.

Thread Size	M3
itpstyli Information	i
Ruby Sphere	20-24
Carbide Stem	21-22
Carbon Fiber Stem	22
Ceramic Stem	23
Stainless Steel Stem	24
Silicon Nitride Sphere	24-26
Carbide Stem	24
Carbon Fiber Stem	25
Ceramic Stem	25
Stainless Steel Stem	26
Zirconium Oxide Sphere	26-27
Carbide Sphere	28
Star Styli	28
Disk Styli	29
Sphere Styli	30
Cylinder Styli	30
XXT (Styli, Extensions and Tools)	35-40
Extensions	
Carbon Fiber	30
Ceramic	31
Stainless Steel	31-32
Holders	32-33
Adapters	33-34
Knuckles	34
Tools	41
Appendix	
Styli Kits	8-9
Vision Kit	13-14
Temp-Comp Specifications	15-16
Material Specifications	17-21
Design Your Own Styli	22-24
Order Form	25

**All prices are quoted in US dollars and are subject to change without notice.
Prices exclude freight, tax, and insurance.**



Welcome to itpstyli

itpstyli is an independent American corporation located in St. Louis Missouri.

itpstyli was created with the sole mission of fulfilling the needs of CMM, machine tool and gear-measurement professionals throughout North America who are looking for a quick and easy method to find and purchase a diverse range of high quality replacement styli, accessories and custom solutions, at lower cost.



Customer Service

The itpstyli customer service promise is simple: Provide customers a friendly, easy, accurate and knowledge-based method of selecting products.

Next day delivery is available when ordered by 3:00 PM CST. With over 7,000 items stocked in our centrally located warehouse we are likely to have what you need in your hands the next day.

In-house CMM professionals are prepared to help you with unique challenges you may face.

Customer service is available during normal business hours: 8 a.m. to 5 p.m. Central Time.

Custom Solutions



Do you need creative solutions for finding the proper stylus for your specific application? itpstyli has experienced CMM operators available to answer your technical questions or to help design the custom stylus needed for your application. Basic "specials" can ship within 72 hours from receipt.



Unconditional Guarantee

Be assured; if you are not happy with our service or product, we will fix the problem to your satisfaction or provide a full refund.

Credit Terms



We accept all major credit cards. We will also accept purchase orders with Net 30 day terms. New customers with business entity addresses in the continental US can place orders up to \$600 credit limit. Credit references may be required at our discretion.



www.itpstyli.com

For those who prefer the convenience of e-commerce, itpstyli hosts a world-class Web site that provides several methods to search, find, and purchase the most appropriate stylus or accessory for your application around the clock. You can order and purchase online or easily generate a fax or purchase order to be sent at your convenience.

itpstyli LLC
 1265 Research Blvd.
 St. Louis, MO 63132

Toll free: 877-478-9587
 Fax : 314-432-3107

sales@itpstyli.com
www.itpstyli.com

M3 Mini Ruby Carbide

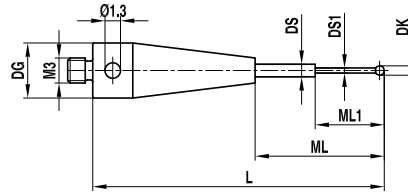

Ball Range
0.2-1.0 mm TN: 71 -- O: 4500

DK	L	ML1 ML	DS1 DS	Weight g	Base/Stem Material	Price \$USD	Part Number
0.2	22.0	2.3/9.0	0.18/1.0	1.0	Stainless steel / Carbide	189.00	TH M3 002 04 022
0.25	22.0	2.3/9.0	0.18/1.0	1.0	Stainless steel / Carbide	189.00	TH M3 0025 04 022
0.3	22.0	2.3/9.0	0.2/1.0	1.0	Stainless steel / Carbide	54.00	TH M3 003 04 022
0.5	22.0	2.5/9.0	0.3/1.0	1.0	Stainless steel / Carbide	42.00	TH M3 005 04 022
0.6	22.0	4.6/9.0	0.4/1.0	1.0	Stainless steel / Carbide	40.00	TH M3 006 04 022
0.8	22.0	4.8/9.0	0.6/1.0	1.0	Stainless steel / Carbide	39.00	TH M3 008 04 022
1.0	10.5	5.0/5.5	0.8/1.0	1.0	Stainless steel / Carbide	33.00	TH M3 010 04 010
1.0	22.0	5.0/9.0	0.8/1.0	1.0	Stainless steel / Carbide	34.00	TH M3 010 04 022

M3 Mini Ruby Stainless Steel

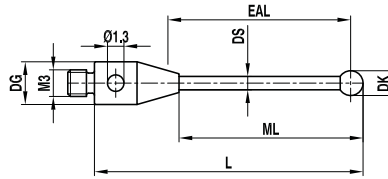

Ball Range
1.0-5.0 mm TN: 130 -- O: 4600

DK	L	ML1 ML	EAL B	DS1 DS	Weight g	Base/Stem Material	Price \$USD	Part Number
1.0	21.5	4.5	4.0	0.7	1.0	Stainless steel	27.00	TI M3 010 04 021
2.0	22.0	9.0	8.0	1.5	1.0	Stainless steel	27.00	TI M3 020 04 022
3.0	22.5	13.5	12.0	1.5	1.0	Stainless steel	24.00	TI M3 030 04 022
4.0	23.0	13.0	17.2	2.5	1.3	Stainless steel	27.00	TI M3 040 04 023
4.0	33.0	23.0	27.0	2.5	2.5	Stainless steel	27.00	TI M3 040 04 033
5.0	23.5	13.5	21.0	2.5	1.5	Stainless steel	30.00	TI M3 050 R4 023
5.0	33.5	33.5	31.0	3.5	3.0	Stainless steel	27.00	TI M3 050 R4 033

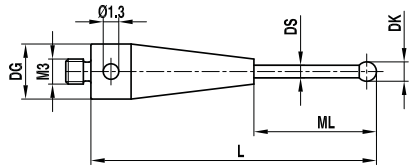

Please note the difference between L and ML; the larger the difference, the longer and more conical the base.

**Ball Range
1.5-6.0 mm**

TN: 71 -- O: 4700

DK	L	DG D	ML1 ML	DS1 DS	Weight g	Base/Stem Material	Price \$USD	Part Number
1.5	22.0	4.0	9.0	1.0	1.0	Stainless steel / Carbide	31.00	TH M3 015 04 022
2.0	21.0	4.0	15.0	1.0	1.0	Stainless steel / Carbide	30.00	TH M3 020 04 021
2.0	22.0	4.0	9.0	1.0	1.0	Stainless steel / Carbide	33.00	TH M3 020 04 022
2.0	40.0	4.0	34.0	1.5	2.0	Stainless steel / Carbide	46.00	TH M3 020 04 040
3.0	50.0	5.5	31.5	2.0	4.5	Stainless steel / Carbide	50.00	TH M3 030 05 050
3.0	21.0	4.0	13.0	2.0	1.0	Stainless steel / Carbide	33.00	TH M3 030 04 021
3.0	21.5	4.0	15.5	1.5	1.0	Stainless steel / Carbide	30.00	TH M3 030 04 022
3.0	40.0	5.5	21.5	2.0	4.0	Stainless steel / Carbide	30.00	TH M3 Z30 05 040
3.0	40.0	5.5	21.5	2.0	4.0	Stainless steel / Carbide	30.00	TH M3 K30 05 040
4.0	30.0	4.0	22.0	2.0	2.0	Stainless steel / Carbide	28.00	TH M3 040 04 030
4.0	40.0	4.0	32.0	2.0	2.0	Stainless steel / Carbide	31.00	TH M3 040 04 040
4.0	50.0	4.0	42.0	2.0	2.9	Stainless steel / Carbide	38.00	TH M3 040 04 050
5.0	30.0	4.0	22.0	2.0	2.1	Stainless steel / Carbide	36.00	TH M3 050 04 030
5.0	40.0	4.0	32.0	2.0	2.0	Stainless steel / Carbide	36.00	TH M3 050 04 040
5.0	50.0	4.0	42.0	2.0	3.0	Stainless steel / Carbide	61.00	TH M3 050 04 050
5.0	60.0	4.0	52.0	2.0	3.5	Stainless steel / Carbide	40.00	TH M3 050 04 060
6.0	30.0	4.0	22.0	2.0	2.3	Stainless steel / Carbide	40.00	TH M3 060 04 030
6.0	40.0	4.0	32.0	2.0	2.7	Stainless steel / Carbide	42.00	TH M3 060 04 040
6.0	50.0	4.0	42.0	2.0	3.2	Stainless steel / Carbide	44.00	TH M3 060 04 050

Got Vision?

itpstyli manufactures a comprehensive line of vision fixturing system parts sold either by the piece or in kits. The components are very high quality while the prices are the lowest available. See Appendix 13 for a complete description.

Vision Systems Fixturing
NOW with abrasion resistant acrylic

Kits Starting at \$860

M3 Ruby Carbide

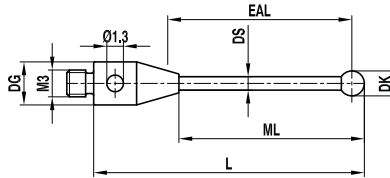

There are more M3 styli and accessories in the XXT section on pages 35-40.

Ball Range 0.5-5.0 mm

TN: 131 -- O: 4800

DK	L	DG D	ML1 ML	DS1 DS	Weight g	Base/Stem Material	Price \$USD	Part Number
0.5	21.25	4.0	2.5	0.4	1.0	Stainless steel / Carbide	81.00	TH M3 005 04 021
1.5	21.75	4.0	14.25	1.0	0.8	Stainless steel / Carbide	42.00	TH M3 015 R4 022
1.5	30.75	4.0	23.25	1.0	1.0	Stainless steel / Carbide	34.00	TH M3 015 04 031
2.0	31.0	4.0	23.5	1.5	1.3	Stainless steel / Carbide	34.00	TH M3 020 04 031
2.0	41.0	4.0	33.5	1.5	1.6	Stainless steel / Carbide	32.00	TH M3 020 04 041
2.5	41.25	4.0	33.75	2.0	2.3	Stainless steel / Carbide	36.00	TH M3 025 04 041
2.5	22.25	4.0	14.75	2.0	1.3	Stainless steel / Carbide	25.00	TH M3 025 04 022
2.5	31.25	4.0	23.75	2.0	1.8	Stainless steel / Carbide	36.00	TH M3 025 04 031
3.0	31.5	4.0	24.0	2.0	1.9	Stainless steel / Carbide	34.00	TH M3 030 04 031
3.0	41.5	4.0	34.0	2.0	2.3	Stainless steel / Carbide	34.00	TH M3 030 04 041
3.0	51.5	4.0	44.0	2.0	2.8	Stainless steel / Carbide	33.00	TH M3 030 04 051
4.0	42.0	4.0	34.5	2.0	2.4	Stainless steel / Carbide	38.00	TH M3 040 04 042
4.0	52.0	4.0	44.5	2.0	2.9	Stainless steel / Carbide	33.00	TH M3 040 04 052
5.0	42.5	4.0	35.0	2.5	3.5	Stainless steel / Carbide	38.00	TH M3 050 04 042
5.0	52.5	4.0	45.0	2.5	4.1	Stainless steel / Carbide	40.00	TH M3 050 04 052

M3 Ruby Carbon Fiber

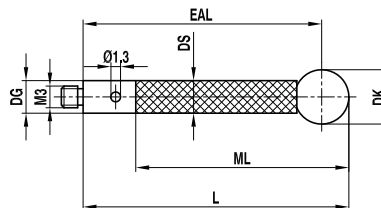

There are more M3 styli and accessories in the XXT section on pages 35-40.

Ball Range 6.0-12.0 mm

TN: 282 -- O: 5000

DK	L	DS1 DS	Weight g	Base/Stem Material	Price \$USD	Part Number
6.0	78.0	4.0	2.4	Stainless steel / Carbon fiber	110.00	TC M3 060 04 078
6.0	103.0	4.0	2.9	Stainless steel / Carbon fiber	130.00	TC M3 060 04 103
8.0	79.0	4.0	3.0	Stainless steel / Carbon fiber	125.00	TC M3 080 04 079
8.0	104.0	4.0	3.5	Stainless steel / Carbon fiber	145.00	TC M3 080 04 104
10.0	80.0	4.0	4.1	Stainless steel / Carbon fiber	155.00	TC M3 100 04 080
10.0	105.0	4.0	4.6	Stainless steel / Carbon fiber	156.00	TC M3 100 04 105
10.0	155.0	4.0	5.5	Stainless steel / Carbon fiber	160.00	TC M3 100 04 155
10.0	205.0	4.0	6.5	Stainless steel / Carbon fiber	165.00	TC M3 100 04 205
12.0	106.0	4.0	5.9	Stainless steel / Carbon fiber	170.00	TC M3 120 04 106
12.0	156.0	4.0	6.9	Stainless steel / Carbon fiber	175.00	TC M3 120 04 156
12.0	206.0	4.0	7.9	Stainless steel / Carbon fiber	180.00	TC M3 120 04 206

**M3
Ruby
Ceramic**

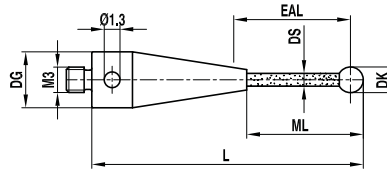

**Ball Range
3.0-5.0 mm**

TN: 133 -- O: 5100

DK	L	ML1 ML	EAL B	DS1 DS	Weight g	Base/Stem Material	Price \$USD	Part Number
3.0	51.5	44.0	42.5	2.0	1.2	Stainless steel / Ceramic	34.00	TK M3 030 04 051
4.0	52.0	44.5	46.0	2.0	1.3	Stainless steel / Ceramic	36.00	TK M3 040 04 052
5.0	52.5	45.0	50.0	2.5	1.4	Stainless steel / Ceramic	37.00	TK M3 050 04 052

**M3
Ruby
Ceramic**

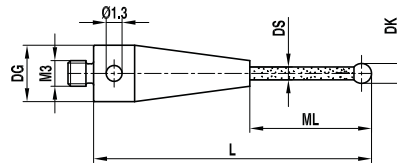

**Ball Range
4.0-8.0 mm**

TN: 72 -- O: 5200

DK	L	ML1 ML	DS1 DS	Weight g	Base/Stem Material	Price \$USD	Part Number
5.0	32.0	19.0	2.0	1.0	Stainless steel / Ceramic	31.00	TK M3 050 04 032
6.0	13.0	9.0	2.0	1.0	Stainless steel / Ceramic	32.00	TK M3 060 04 013
6.0	43.5	30.5	2.0	1.2	Stainless steel / Ceramic	58.00	TK M3 060 04 043
6.0	63.5	50.5	2.0	1.5	Stainless steel / Ceramic	65.00	TK M3 060 04 063
8.0	31.5	18.5	2.0	1.3	Stainless steel / Ceramic	78.00	TK M3 080 04 031

**M3
Ruby
Stainless Steel**

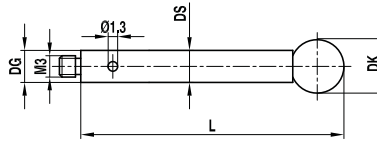

**Ball Range
5.0-6.0 mm**

TN: 148 -- O: 5300

DK	L	DS1 DS	Weight g	Base/Stem Material	Price \$USD	Part Number
5.0	23.5	4.0	2.2	Stainless steel	27.00	TI M3 050 04 023
5.0	33.5	4.0	3.1	Stainless steel	27.00	TI M3 050 04 033
5.0	42.5	4.0	4.1	Stainless steel	29.00	TI M3 050 04 042
5.0	52.5	4.0	5.1	Stainless steel	30.00	TI M3 050 04 052
6.0	24.0	4.0	2.3	Stainless steel	33.00	TI M3 060 04 024
6.0	34.0	4.0	3.2	Stainless steel	37.00	TI M3 060 04 034
6.0	43.0	4.0	4.3	Stainless steel	38.00	TI M3 060 04 043
6.0	53.0	4.0	5.2	Stainless steel	42.00	TI M3 060 04 053

**M3
Silicon Nitride
Carbide**

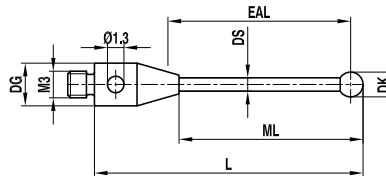

**Ball Range
1.5-5.0 mm**

TN: 202 -- O: 5400

DK	L	ML1 ML	EAL B	DS1 DS	Weight g	Base/Stem Material	Price \$USD	Part Number
1.5	21.75	14.25	12.5	1.0	0.8	Stainless steel / Carbide	61.00	TH M3 S15 R4 022
1.5	30.75	23.25	22.5	1.0	1.0	Stainless steel / Carbide	53.00	TH M3 S15 04 031
2.0	31.0	23.5	22.5	1.5	1.3	Stainless steel / Carbide	59.00	TH M3 S20 04 031
2.0	41.0	33.5	32.5	1.5	1.6	Stainless steel / Carbide	53.00	TH M3 S20 04 041
2.5	41.25	33.75	32.5	2.0	2.3	Stainless steel / Carbide	55.00	TH M3 S25 04 041
2.5	22.25	14.75	12.5	2.0	1.3	Stainless steel / Carbide	51.00	TH M3 S25 04 022
2.5	31.25	23.75	22.5	2.0	1.8	Stainless steel / Carbide	49.00	TH M3 S25 04 031
3.0	31.5	24.0	22.5	2.0	1.9	Stainless steel / Carbide	55.00	TH M3 S30 04 031
3.0	41.5	34.0	32.5	2.0	2.3	Stainless steel / Carbide	53.00	TH M3 S30 04 041
3.0	51.5	44.0	42.5	2.0	2.8	Stainless steel / Carbide	53.00	TH M3 S30 04 051
4.0	42.0	34.5	40.0	2.0	2.4	Stainless steel / Carbide	52.00	TH M3 S40 04 042
4.0	52.0	44.5	50.0	2.0	2.9	Stainless steel / Carbide	57.00	TH M3 S40 04 052
5.0	42.5	35.0	40.0	2.5	3.5	Stainless steel / Carbide	52.00	TH M3 S50 04 042
5.0	52.5	45.0	50.0	2.5	4.1	Stainless steel / Carbide	57.00	TH M3 S50 04 052

**M3
Silicon Nitride
Carbon Fiber**

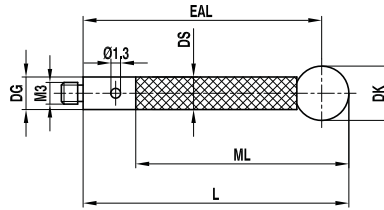

There are more M3 styli and accessories in the XXT section on pages 35-40.

Ball Range 6.0-8.0 mm TN: 283 -- O: 5500

DK	L	DS1 DS	Weight g	Base/Stem Material	Price \$USD	Part Number
6.0	78.0	4.0	2.4	Stainless steel / Carbon fiber	135.00	TC M3 S60 04 078
6.0	103.0	4.0	2.9	Stainless steel / Carbon fiber	155.00	TC M3 S60 04 103
8.0	79.0	4.0	3.0	Stainless steel / Carbon fiber	150.00	TC M3 S80 04 079
8.0	104.0	4.0	3.5	Stainless steel / Carbon fiber	170.00	TC M3 S80 04 104

**M3
Silicon Nitride
Ceramic**

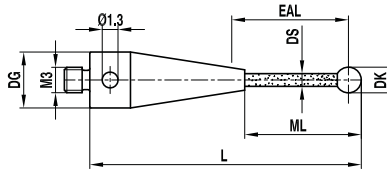

Ball Range 3.0-5.0 mm TN: 203 -- O: 5700

DK	L	ML1 ML	EAL B	DS1 DS	Weight g	Base/Stem Material	Price \$USD	Part Number
3.0	51.5	44.0	42.5	2.0	1.2	Stainless steel / Ceramic	53.00	TK M3 S30 04 051
4.0	52.0	44.5	46.0	2.0	1.3	Stainless steel / Ceramic	55.00	TK M3 S40 04 052
5.0	52.5	45.0	50.0	2.5	1.4	Stainless steel / Ceramic	56.00	TK M3 S50 04 052

**M3
Silicon Nitride
Stainless Steel**

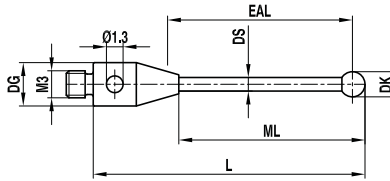

**Ball Range
1.0-5.0 mm** TN: 204 -- O: 5800

DK	L	ML1 ML	EAL B	DS1 DS	Weight g	Base/Stem Material	Price \$USD	Part Number
1.0	21.5	4.5	4.0	0.7	1.0	Stainless steel	46.00	TI M3 S10 04 021
2.0	22.0	9.0	8.0	1.5	1.0	Stainless steel	45.00	TI M3 S20 04 022
3.0	22.5	13.5	12.0	1.5	1.0	Stainless steel	46.00	TI M3 S30 04 022
4.0	23.0	13.0	17.2	2.5	1.3	Stainless steel	46.00	TI M3 S40 04 023
4.0	33.0	23.0	27.0	2.5	2.5	Stainless steel	46.00	TI M3 S40 04 033
5.0	23.5	13.5	21.0	2.5	1.5	Stainless steel	46.00	TI M3 S50 R4 023
5.0	33.5	33.5	31.0	3.5	3.0	Stainless steel	46.00	TI M3 S50 R4 033

**M3
Zirconium Oxide
Carbide**

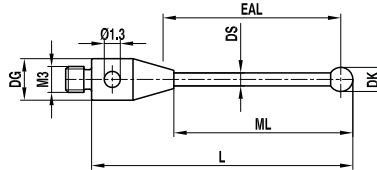

**Ball Range
2.0 mm** TN: 274 -- O: 5900

DK	L	DG D	ML1 ML	DS1 DS	Weight g	Base/Stem Material	Price \$USD	Part Number
2.0	31.0	4.0	23.5	1.5	1.4	Stainless steel / Carbide	92.00	TH M3 Z20 04 031

**M3
Zirconium Oxide
Carbon Fiber**

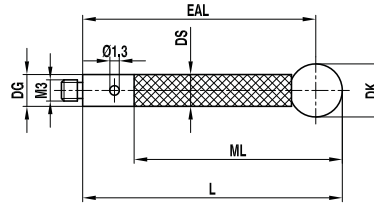

**Ball Range
6.0-8.0 mm**

TN: 284 -- O: 6000

DK	L	DS1 DS	Weight g	Base/Stem Material	Price \$USD	Part Number
6.0	78.0	4.0	3.4	Stainless steel / Carbon fiber	135.00	TC M3 Z60 04 078
6.0	103.0	4.0	3.9	Stainless steel / Carbon fiber	155.00	TC M3 Z60 04 103
8.0	79.0	4.0	3.5	Stainless steel / Carbon fiber	150.00	TC M3 Z80 04 079
8.0	104.0	4.0	4.0	Stainless steel / Carbon fiber	170.00	TC M3 Z80 04 104

**M3
Zirconium Oxide
Ceramic**

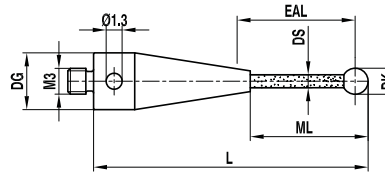

**Ball Range
4.0 mm**

TN: 275 -- O: 6100

DK	L	ML1 ML	EAL B	DS1 DS	Weight g	Base/Stem Material	Price \$USD	Part Number
4.0	52.0	44.5	50.0	2.0	1.5	Stainless steel / Ceramic	96.00	TK M3 Z40 04 052

**M3
Zirconium Oxide
Stainless Steel**

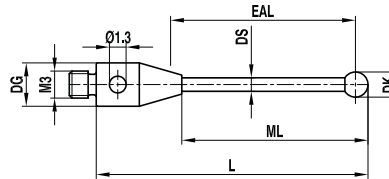

**Ball Range
2.0-4.0 mm**

TN: 276 -- O: 6200

DK	L	ML1 ML	EAL B	DS1 DS	Weight g	Base/Stem Material	Price \$USD	Part Number
2.0	22.0	9.0	8.0	1.5	1.0	Stainless steel	87.00	T1 M3 Z20 04 022
4.0	23.0	13.0	17.2	2.5	1.6	Stainless steel	50.00	T1 M3 Z40 04 023

**M3
Carbide
Carbide**

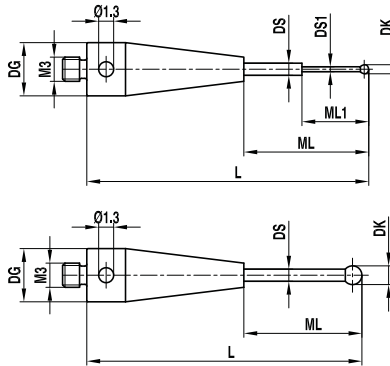

Tungsten Carbide is a low-weight option normally used on articulated arms. It has better shock absorption, but surface features are lower than ruby, and it is not suited to ball sizes smaller than 1 mm diameter. Please see the appendix to assess the best materials for your applications.

**Ball Range
1.0-8.0 mm**

TN: 413 -- O: 6250

DK	ML1 ML	DG D	L	DS1 DS	Base/Stem Material	Price \$USD	Part Number
1.0	5.0/14.0	4.0	21.5	0.7/1.0	Stainless steel / Carbide	50.00	TH M3 010 H4 021
2.0	14.5	4.0	22.0	1.0	Stainless steel / Carbide	50.00	TH M3 020 H4 022
3.0	15.0	4.0	22.5	1.0	Stainless steel / Carbide	50.00	TH M3 030 H4 022
4.0	15.0	4.0	23.0	2.0	Stainless steel / Carbide	50.00	TH M3 040 H4 023
4.0	34.0	4.0	42.0	2.0	Stainless steel / Carbide	50.00	TH M3 040 H4 042
5.0	34.5	4.0	42.5	2.0	Stainless steel / Carbide	50.00	TH M3 050 H4 042
6.0	35.0	4.0	43.0	2.0	Stainless steel / Carbide	50.00	TH M3 060 H4 043
8.0	34.0	4.0	44.0	3.0	Stainless steel / Carbide	63.00	TH M3 080 H4 044

**M3
Ruby
Star & Holder
Stainless Steel**

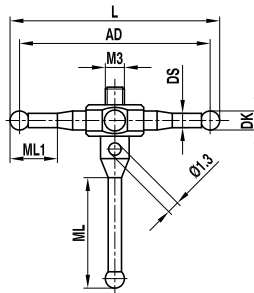

The horizontal arms are fixed in place and cannot be replaced. Two-piece construction allows one to clock the horizontal arms.

**Ball Range
2.0 mm**

TN: 134 -- O: 6300

DK	L	AD	ML1 ML	DS1 DS	Weight g	Base & Arms	Price \$USD	Part Number
2.0	32.0	30.0	9.5 / 12.5	1.4	3.0	Stainless steel	122.00	SI M3 020 07 032
2.0	52.0	50.0	12.0 / 12.0	1.4	5.3	Stainless steel	125.00	SI M3 020 07 052

**M3
Disks
Stainless Steel**

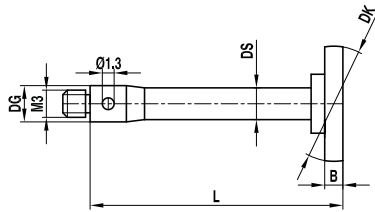

**Disk Range
12.7 mm** TN: 181 -- O: 6400

DK	EAL B	L	DS1 DS	Weight g	Stem/Disk Material	Price \$USD	Part Number
12.7	2.3	32.0	3.5	4.0	Stainless steel	67.00	KI M3 127 04 032

**M3
Disks
Stainless Steel**

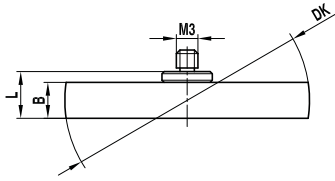

**Disk Range
35.0-63.5 mm** TN: 180 -- O: 6500

DK	EAL B	L	Weight g	Disk Material	Price \$USD	Part Number
35.0	5.0	7.0	10.0	Stainless steel	106.00	KI M3 050 35 M30
63.5	6.0	7.5	45.0	Stainless steel	121.00	KI M3 060 63 M30

**M3
Spherical Stylus
Ceramic**

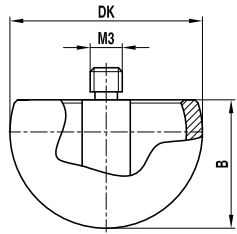

**Hollow Sphere
18.0-30.0 mm** TN: 182 -- O: 6600

DK	EAL B	Weight g	Base/Body Material	Price \$USD	Part Number
18.0	12.0	3.3	Stainless steel / Ceramic	300.00	HK M3 180 04 012
30.0	18.0	18.0	Stainless steel / Ceramic	520.00	HK M3 300 04 018

M3 Cylinder Carbide

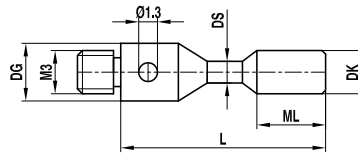

Cylinder
1.5-3.0 mm TN: 77 -- O: 6700

DK	L	DG D	ML1 ML	DS1 DS	Weight g	Base Material	Cylinder Material	Price \$USD	Part Number
1.5	11.0	4.0	1.5	1.0	0.4	Stainless steel / Carbide	Carbide	19.00	ZH M3 015 04 011
3.0	13.0	4.0	4.0	1.5	0.7	Stainless steel / Carbide	Carbide	19.00	ZH M3 030 04 013

M3 Cylinder Ruby

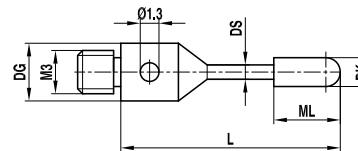

Cylinder
2.0 mm TN: 308 -- O: 6800

DK	L	DG D	ML1 ML	DS1 DS	Weight g	Base/Stem Material	Cylinder Material	Price \$USD	Part Number
2.0	20.0	4.0	7.0	1.5	0.7	Stainless steel / Carbide	Ruby	100.00	ZR M3 020 04 020

M3 Extensions Carbon Fiber

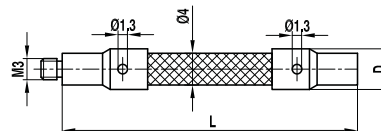

Length Range
75.00-100.00 mm TN: 277 -- O: 6900

L	DG D	Weight g	Body Material	End Material	Price \$USD	Part Number
75.0	6.0	2.5	Carbon fiber	Stainless Steel	97.00	VC M3 000 04 075
100.0	6.0	3.0	Carbon fiber	Stainless Steel	104.00	VC M3 000 04 100

There are more M3
styli and accessories in
the XXT section on
pages 35-40.

**M3
Extensions
Ceramic**

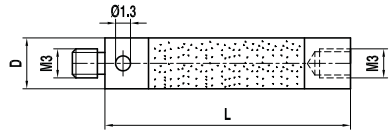

**Length Range
30.00-60.00 mm**

TN: 137 -- O: 7100

L	DG D	Weight g	Body Material	End Material	Price \$USD	Part Number
30.0	4.0	2.0	Ceramic	Stainless Steel	37.00	VK M3 000 04 030
40.0	4.0	2.5	Ceramic	Stainless Steel	38.00	VK M3 000 04 040
50.0	4.0	3.0	Ceramic	Stainless Steel	40.00	VK M3 000 04 050
60.0	4.0	3.5	Ceramic	Stainless Steel	40.00	VK M3 000 04 060

**M3
Extensions
Stainless Steel**

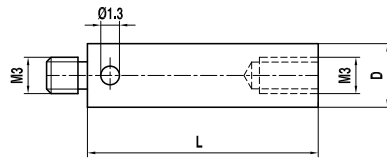

**Length Range
10.00-50.00 mm**

TN: 73 -- O: 7200

L	DG D	Weight g	Body Material	Price \$USD	Part Number
10.0	4.0	0.7	Stainless steel	10.00	VI M3 000 04 010
20.0	4.0	1.6	Stainless steel	10.00	VI M3 000 04 020
30.0	4.0	2.6	Stainless steel	11.00	VI M3 000 04 030
35.0	4.0	2.9	Stainless steel	11.00	VI M3 000 04 035
40.0	4.0	3.7	Stainless steel	15.00	VI M3 000 04 040
50.0	4.0	4.7	Stainless steel	19.00	VI M3 000 04 050

**M3
Extensions
Stainless Steel**

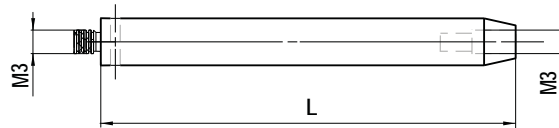

**Length Range
50.00 mm**

TN: 414 -- O: 7350

DG D	L	Body Material	Price \$USD	Part Number
6.0	50.0	Stainless steel	63.00	VI M3 000 H6 050

**M3
90° Holder
Stainless Steel**

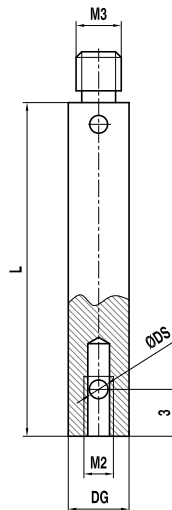

Use with non-threaded styli with matching DS on pages 76-78.

1-Way 90° Holder

TN: 349 -- O: 7400

DS1 DS	L	Weight g	Material	Price \$USD	Part Number
1.0	30.0	2.9	Stainless steel	59.00	KH M3 010 04 030
1.5	30.0	2.9	Stainless steel	61.00	KH M3 015 04 030

**M3
Rotary Holder
Stainless Steel**

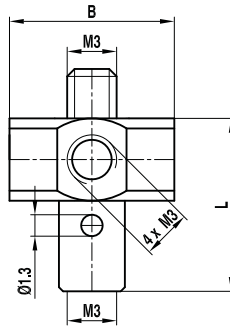

This is a two-piece construction to allow for clocking.

5-Way Holder

TN: 74 -- O: 7500

EAL B	L	Weight g	Material	Price \$USD	Part Number
10.0	13.0	3.6	Stainless steel	48.00	HI M3 000 10 013
12.0	11.5	4.2	Stainless steel	42.00	HI M3 000 12 011

**M3
Adapters
Stainless Steel**

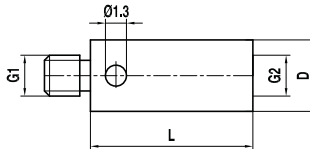

M3-M2 Adapter

TN: 88 -- O: 7700

from to	DG D	L	Weight g	Body Material	Price \$USD	Part Number
M2 / M3	4.0	5.0	0.5	Stainless steel	10.00	RI M2 000 04 005
M2 / M3	4.0	7.0	0.5	Stainless steel	10.00	RI M2 000 04 007
M3 / M2	4.0	5.0	0.5	Stainless steel	10.00	RI M3 000 04 005

**M3
Rotary Adapter
Stainless Steel**

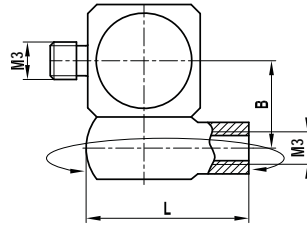

Rotary Adapter

TN: 76 -- O: 7800

L	EAL B	Weight g	Material	Price \$USD	Part Number
12.0	6.0	3.6	Stainless steel	43.00	DI M3 000 06 012

**M3
Rotary Knuckle
Stainless Steel**

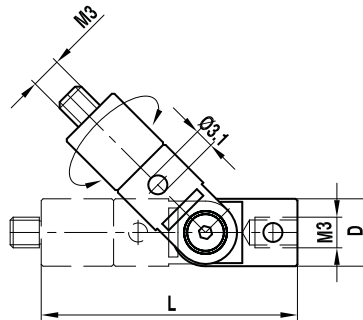

Rotary Knuckle

TN: 293 -- O: 7900

L	DG D	Weight g	Material	Price \$USD	Part Number
17.0	4.0	1.5	Stainless steel	123.00	GI M3 000 04 017

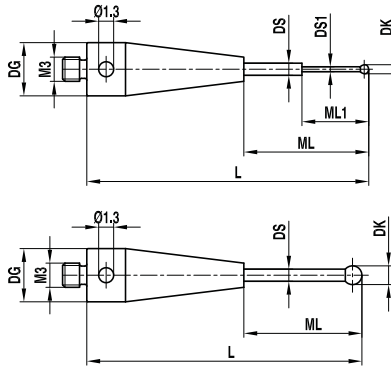

These styli are designed to be used with Zeiss XXT probing systems.

**Ball Range
0.3-2.5 mm**

TN: 402 -- O: 7902

DK	ML1 ML	DG D	L	DS1 DS	Weight g	Base/Stem Material	Price \$USD	Part Number
0.3	2.3/4.0	5.0	13.0	0.2/1.0	0.62	Stainless steel / Carbide	52.00	TH M3 003 05 013
0.3	2.3/11.0	5.0	20.0	0.2/1.0	0.69	Stainless steel / Carbide	52.00	TH M3 003 05 020
0.5	2.3/4.0	5.0	13.0	0.3/1.0	0.61	Stainless steel / Carbide	52.00	TH M3 005 05 013
0.5	2.3/11.0	5.0	20.0	0.3/1.0	0.69	Stainless steel / Carbide	52.00	TH M3 005 05 020
0.6	4.6/5.0	5.0	14.0	0.4/1.0	0.61	Stainless steel / Carbide	41.00	TH M3 006 05 014
0.6	4.6/11.0	5.0	20.0	0.4/1.0	0.68	Stainless steel / Carbide	44.00	TH M3 006 05 020
0.8	5.0	5.0	14.0	0.6	0.62	Stainless steel / Carbide	41.00	TH M3 008 05 014
0.8	4.8/11.0	5.0	20.0	0.6/1.0	0.69	Stainless steel / Carbide	41.00	TH M3 008 05 020
0.8	4.1/25.0	5.0	34.0	0.6/1.0	0.80	Stainless steel / Carbide	50.00	TH M3 008 05 034
1.0	5.0	5.0	14.0	0.8	0.63	Stainless steel / Carbide	42.00	TH M3 010 05 014
1.0	5.1/11.0	5.0	20.0	0.6/1.0	0.70	Stainless steel / Carbide	46.00	TH M3 010 05 020
1.0	5.0/11.0	5.0	20.0	0.8/1.0	0.69	Stainless steel / Carbide	44.00	TH M3 010 05 020/0.8
1.0	5.0/21.0	5.0	30.0	0.8/1.0	0.80	Stainless steel / Carbide	46.00	TH M3 010 05 030
1.0	5.0/31.0	5.0	40.0	0.8/1.0	1.5	Stainless steel / Carbide	47.00	TH M3 010 05 040
1.5	5.0	5.0	14.0	1.0	0.65	Stainless steel / Carbide	41.00	TH M3 015 05 014
1.5	11.0	5.0	20.0	1.0	0.72	Stainless steel / Carbide	44.00	TH M3 015 05 020
1.5	21.0	5.0	30.0	1.0	0.84	Stainless steel / Carbide	45.00	TH M3 015 05 030/9.0
1.5	22.5	5.0	30.0	1.0	0.90	Stainless steel / Carbide	49.00	TH M3 015 05 030
1.5	31.0	5.0	40.0	1.0	1.60	Stainless steel / Carbide	50.00	TH M3 015 05 040
2.0	5.0	5.0	14.0	1.0	0.66	Stainless steel / Carbide	42.00	TH M3 020 05 014
2.0	11.0	5.0	20.0	1.0	0.72	Stainless steel / Carbide	45.00	TH M3 020 05 020
2.0	21.0	5.0	30.0	1.0	0.83	Stainless steel / Carbide	44.00	TH M3 020 05 030
2.0	31.0	5.0	40.0	1.5	1.70	Stainless steel / Carbide	46.00	TH M3 020 05 040
2.5	11.0	5.0	20.0	1.5	1.0	Stainless steel / Carbide	44.00	TH M3 025 05 020
2.5	21.0	5.0	30.0	1.5	1.5	Stainless steel / Carbide	45.00	TH M3 025 05 030
2.5	31.0	5.0	40.0	1.5	2.0	Stainless steel / Carbide	46.00	TH M3 025 05 040

**M3
Ruby XXT
Carbon Fiber**

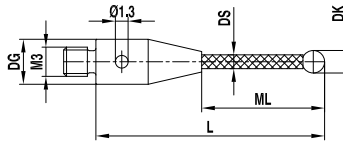

The styli on this page are designed to be used with Zeiss XXT probing systems.

**Ball Range
3.0-8.0 mm**

TN: 404 – O: 7903

DK	ML1 ML	DG D	L	DS1 DS	Weight g	Base/Stem Material	Price \$USD	Part Number
3.0	16.00	5.0	25.0	2.0	0.65	Stainless steel / Carbon fiber	64.00	TC M3 030 05 025
3.0	24.0	5.0	33.0	2.0	0.70	Stainless steel / Carbon fiber	70.00	TC M3 030 05 033
3.0	33.0	5.0	42.0	2.0	0.80	Stainless steel / Carbon fiber	72.00	TC M3 030 05 042
3.0	41.0	5.0	50.0	2.0	0.80	Stainless steel / Carbon fiber	72.00	TC M3 030 05 050
3.0	50.0	5.0	59.0	2.0	1.0	Stainless steel / Carbon fiber	77.00	TC M3 030 05 059
3.0	66.0	5.0	75.0	2.0	1.0	Stainless steel / Carbon fiber	78.00	TC M3 030 05 075
4.0	41.0	5.0	50.0	2.0	1.0	Stainless steel / Carbon fiber	72.00	TC M3 040 05 050
5.0	21.0	5.0	30.0	3.5	1.1	Stainless steel / Carbon fiber	77.00	TC M3 050 05 030/9
5.0	31.0	5.0	40.0	3.5	1.2	Stainless steel / Carbon fiber	77.00	TC M3 050 05 040
5.0	41.0	5.0	50.0	3.5	1.4	Stainless steel / Carbon fiber	77.00	TC M3 050 05 050
5.0	51.0	5.0	60.0	3.5	1.5	Stainless steel / Carbon fiber	78.00	TC M3 050 05 060
5.0	66.0	5.0	75.0	3.5	1.8	Stainless steel / Carbon fiber	82.00	TC M3 050 05 075
6.0	40.0	5.0	50.0	3.5	1.5	Stainless steel / Carbon fiber	91.00	TC M3 060 05 050
6.0	61.0	5.0	70.0	3.5	1.8	Stainless steel / Carbon fiber	92.00	TC M3 060 05 070
6.0	91.0	5.0	100.0	3.5	2.4	Stainless steel / Carbon fiber	93.00	TC M3 060 05 100
8.0	30.0	5.0	30.0	5.0	1.86	Stainless steel / Carbon fiber	100.00	TC M3 080 05 030
8.0	50.0	5.0	50.0	5.0	2.1	Stainless steel / Carbon fiber	108.00	TC M3 080 05 050
8.0	70.0	5.0	70.0	5.0	2.6	Stainless steel / Carbon fiber	111.00	TC M3 080 05 070
8.0	100.00	5.0	100.0	5.0	2.7	Stainless steel / Carbon fiber	115.00	TC M3 080 05 100
8.0	125.0	5.0	125.0	5.0	2.9	Stainless steel / Carbon fiber	118.00	TC M3 080 05 125

**M3
Ruby XXT
Clamping Styli
Carbon Fiber**

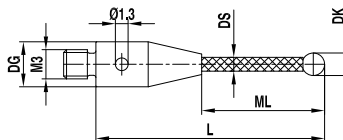

**Ball Range
3.0 mm**

TN: 407 – O: 7904

DK	ML1 ML	DG D	L	DS1 DS	Weight g	Body Material	Price \$USD	Part Number
3.0	11.0	5.0	20.0	2.0	0.7	Stainless steel / Carbon fiber	72.00	TC M3 030 05 020
3.0	21.0	5.0	30.0	2.0	0.75	Stainless steel / Carbon fiber	76.00	TC M3 030 05 030
3.0	31.0	5.0	40.0	2.0	0.8	Stainless steel / Carbon fiber	69.00	TC M3 030 05 040

**M3
Silicon Nitride
Clamping Styli
XXT
Carbon Fiber**

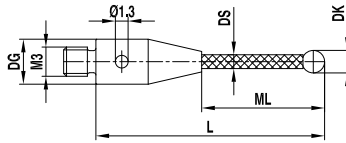

The styli on this page are designed to be used with Zeiss XXT probing systems.

**Ball Range
3.0 mm**

TN: 409 - O: 7905

DK	ML1 ML	DG D	L	DS1 DS	Weight g	Body Material	Price \$USD	Part Number
3.0	11.0	5.0	20.0	2.0	0.7	Stainless steel / Carbon fiber	82.00	TC M3 S30 05 020
3.0	21.0	5.0	30.0	2.0	0.75	Stainless steel / Carbon fiber	86.00	TC M3 S30 05 030
3.0	31.0	5.0	40.0	2.0	0.8	Stainless steel / Carbon fiber	88.00	TC M3 S30 05 040

**M3
Silicon Nitride
XXT
Carbon Fiber**

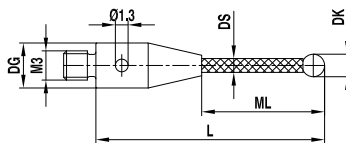

**Ball Range
3.0-8.0 mm**

TN: 406 - O: 7906

DK	ML1 ML	DG D	L	DS1 DS	Weight g	Body Material	Price \$USD	Part Number
3.0	24.0	5.0	33.0	2.0	0.7	Stainless steel / Carbon fiber	95.00	TC M3 S30 05 033
3.0	41.0	5.0	50.0	2.0	0.8	Stainless steel / Carbon fiber	97.00	TC M3 S30 05 050
5.0	41.0	5.0	50.0	3.5	1.4	Stainless steel / Carbon fiber	104.00	TC M3 S50 05 050
5.0	66.0	5.0	75.0	3.5	1.8	Stainless steel / Carbon fiber	106.00	TC M3 S50 05 075
8.0	70.0	5.0	70.0	5.0	2.6	Stainless steel / Carbon fiber	160.00	TC M3 S80 05 070
8.0	125.0	5.0	125.0	5.0	2.9	Stainless steel / Carbon fiber	173.00	TC M3 S80 05 125

**Can't find what you need in the catalog?
--- Build your own ---**

Need an extra 2 mm in measuring length? Want to switch out ball diameters or materials? We'll do it. The schematics shown below are the starting point. Visit www.itpstyli.com, select "Design your own," and fill in the interactive spec sheet. We'll provide a quote within a couple of hours and ship the product in as soon as 72 hours.

				And more with your own drawing	

**M3
Reference Styli
XXT
Stainless Steel**

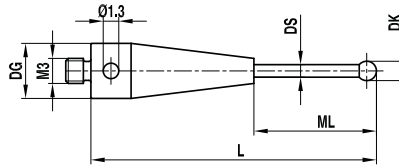

The pieces on this page are designed to be used with Zeiss XXT probing systems.

**Master Probe
Red Dot**

TN: 403 – O: 7907

DK	ML1 ML	DG D	L	DS1 DS	Weight g	Base/Stem Material	Price \$USD	Part Number
5.0	21.0	5.0	30.0	3.5	1.1	Stainless steel	77.00	TC M3 R50 05 030
5.0	41.0	5.0	50.0	3.5	1.4	Stainless steel	77.00	TC M3 R50 05 050

**M3
Extensions XXT
Carbon Fiber**

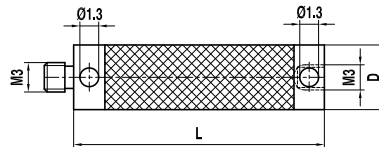

**Length Range
30.00-150.00 mm**

TN: 410 – O: 7908

L	DG D	Weight g	Body Material	Price \$USD	Part Number
20.0	5.0	1.2	Carbon fiber	75.00	VC M3 000 05 020
25.0	5.0	1.25	Carbon fiber	79.00	VC M3 000 05 025
30.0	5.0	1.3	Carbon fiber	82.00	VC M3 000 05 030
40.0	5.0	1.4	Carbon fiber	88.00	VC M3 000 05 040
50.0	5.0	1.5	Carbon fiber	95.00	VC M3 000 05 050
60.0	5.0	1.7	Carbon fiber	97.00	VC M3 000 05 060
75.0	5.0	1.7	Carbon fiber	100.00	VC M3 000 05 075
80.0	5.0	1.8	Carbon fiber	105.00	VC M3 000 05 080
100.0	5.0	2.0	Carbon fiber	109.00	VC M3 000 05 100
130.0	5.0	2.5	Carbon fiber	112.00	VC M3 000 05 130
150.0	5.0	2.7	Carbon fiber	118.00	VC M3 000 05 150

**M3
Knuckle XXT
Titanium**

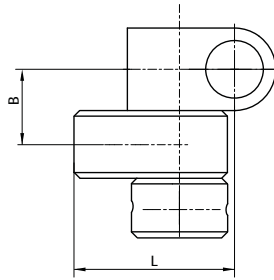

The pieces on this page are designed to be used with Zeiss XXT probing system.

Knuckle XXT

TN: 420 -- O: 7909

L	EAL B	Weight g	Body Material	Price \$USD	Part Number
10.0	5.0	1.65	Titanium	133.00	DT M3 000 05 010

**M3
Clamping Screw
XXT
Stainless Steel**

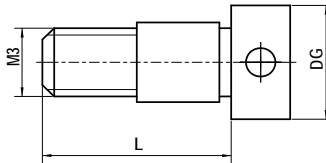

**Clamping Screw
XXT**

TN: 411 -- O: 7910

DG D	L	Weight g	Body Material	Price \$USD	Part Number
5.0	8.0	0.5	Stainless steel	13.00	SI M3 000 05 008

**M3
Clamping Screw
XXT
Stainless Steel**

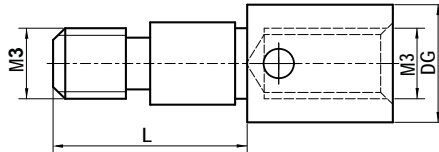

**With Internal
M3 Thread**

TN: 412 -- O: 7911

DG D	L	Weight g	Body Material	Price \$USD	Part Number
5.0	8.0	0.7	Stainless steel	13.00	SI M3 M30 05 008

**M3
Cube XXT
Titanium**

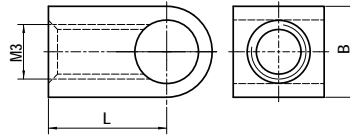

The pieces on this page are designed to be used with Zeiss XXT probing systems.

90 Degrees, 1-way TN: 417 -- O: 7912

L	EAL B	Weight g	Body Material	Price \$USD	Part Number
6.5	5.0	0.64	Titanium	42.75	WT M3 000 05 006

**M3
Cube XXT
Titanium**

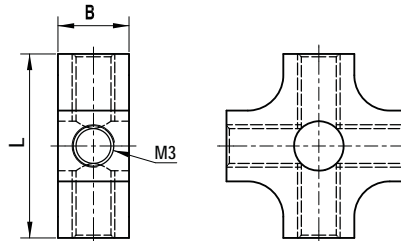

180 Degrees, 2-way TN: 418 -- O: 7913

L	EAL B	Weight g	Body Material	Price \$USD	Part Number
13.0	5.0	1.05	Titanium	57.00	WT M3 180 05 013

**M3
Cube XXT
Titanium**

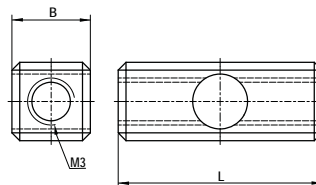

Star TN: 419 -- O: 7914

L	EAL B	Weight g	Body Material	Price \$USD	Part Number
13.0	5.0	1.8	Titanium	52.25	WT M3 000 05 013



Assembly Tool

TN: 96 – O: 7918

Body Material	Price \$USD	Part Number
Stainless steel	78.00	TF M2 M30 08 195



Hexagonal Wrench

TN: 97 – O: 7920

SW	Body Material	Price \$USD	Part Number
0.9	Steel	3.00	WS DD 911 SW 009
1.5	Steel	3.00	WS DD 911 SW 015
2.0	Steel	3.00	WS DD 911 SW 020
2.5	Steel	3.00	WS DD 911 SW 025
3.0	Steel	3.00	WS DD 911 SW 030
4.0	Steel	3.00	WS DD 911 SW 040
5.0	Steel	3.00	WS DD 911 SW 050
10.0	Steel	3.00	WS DD 911 SW 100

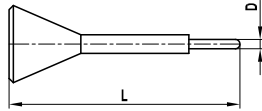

Locking Wrench

TN: 95 – O: 7930

DG D	L	Body Material	Price \$USD	Part Number
1.2	23.0	Stainless steel	9.00	MI MO 012 00 023

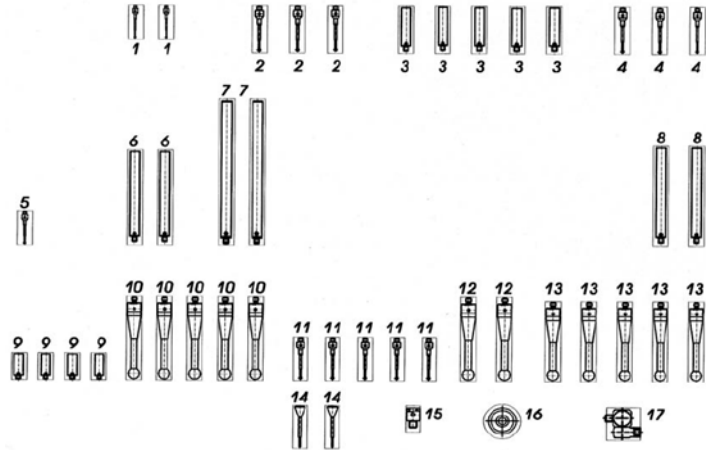

TB M3 046 09 255
Price: \$1331.00

Part Number	Description	Quantity	Position
TK M3 060 04 013	M3 straight stylus, ceramic – Ø=6.0 L=13.0	2	1
TH M3 030 04 021	M3 straight stylus, carbide – Ø=3.0 L=21.0 ML=13.0	3	2
VI M3 000 04 020	M3 extension, steel – L=20.0	5	3
TH M3 010 04 022	M3 straight stylus, carbide – Ø=1.0 L=22.0	3	4
TH M3 010 04 010	M3 straight stylus, carbide – Ø=1.0 L=10.0	1	5
VI M3 000 04 040	M3 extension, steel – L=40.0	2	6
VI M3 000 04 050	M3 extension, steel – L=50.0	2	7
VI M3 000 04 030	M3 extension, steel – L=30.0	2	8
VI M3 000 04 010	M3 extension, steel – L=10.0	4	9
TH M3 K30 05 040	M3 straight stylus, carbide – Ø=3.0 L=40.0	5	10
TH M3 020 04 021	M3 straight stylus, carbide – Ø=2.0 L=21.0 ML=15.0	5	11
TK M3 050 04 032	M3 straight stylus, ceramic – Ø=5.0 L=32.0	2	12
TK M3 040 04 032	M3 straight stylus, ceramic – Ø=4.0 L=32.0	5	13
MI MO 012 00 023	Pin type wrench	2	14
RI M3 000 04 005	M3/M2 adapter	1	15
HI M3 000 12 011	M3 star center	1	16
DI M3 000 06 012	M3 adjustable knuckle	1	17
Box		1	

**M3
Styli Kit
14 Pieces**

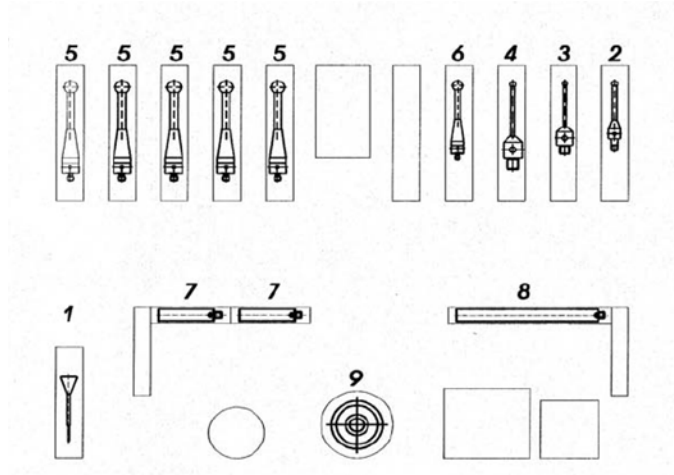

TB M3 015 09 252
Price: \$387.00

Part Number	Description	Quantity	Position
MI MO 012 00 023	Pin type wrench	1	1
TK M3 060 04 013	M3 straight stylus, ceramic – Ø=3.0 L=13.0	1	2
TH M3 030 04 022	M3 straight stylus, carbide – Ø=3.0 L=22.0	1	3
TH M3 020 04 021	M3 straight stylus, carbide – Ø=2.0 L=21.0	1	4
TH M3 020 04 022	M3 straight stylus, carbide – Ø=2.0 L=22.0	5	5
TH M3 030 04 021	M3 straight stylus, carbide – Ø=3.0 L=21.0	1	6
VI M3 000 04 010	M3 extension, steel – L=10.0	2	7
VI M3 000 04 020	M3 extension, steel – L=20.0	1	8
HI M3 000 04 020	M3 star center	1	9
Box		1	

Vision Fixturing Systems

High quality components, affordable costs, effective solutions

Why purchase an



Vision Fixture System?

- Simplify multiple part inspections
- Improved location and orientation accuracy
- Transfer fixturing set-up information to other operators with grid identification
- Faster setup and cycle time
- Improved measurement repeatability
- Ideal for Quality Certification Processes
- Can be used with literally any vision or multi-sensor machine
- Best value available
- Same-day shipping available
- Pre-configured kits make it easy to start
- All parts available as individual items with no minimum orders

sales@itpstyli.com ● www.itpstyli.com

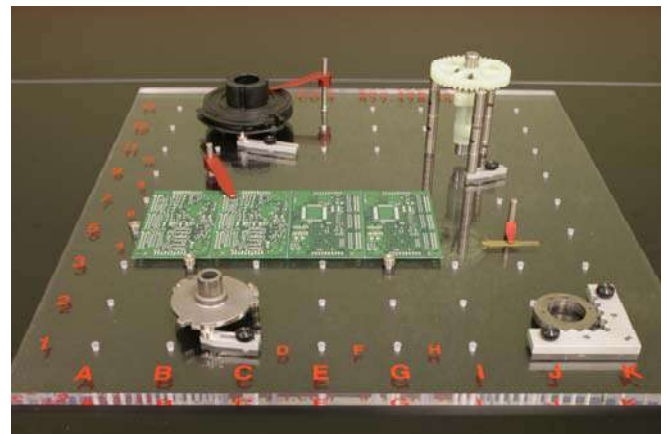

Acrylic Plates

- VP 150 – 6 x 6 in. (152x152 mm) - \$225.00
- VP 200 HFC – 8 x 8 in. (203x203 mm) - \$335.00
- VP 500 HFC – 18 x 20 in. (457x508 mm) - \$415.00

Pre-Configured Vision Fixture Kits

Quantities Included per Kit			
	<u>Kit 150</u>	<u>Kit 200</u>	<u>Kit 500</u>
Acrylic Plate <i>Hole Free Center*</i>	1, 6 x 6in. (152 x 152 mm)	1, 8 x 8in. (203 x 203 mm)	1, 18 x 20in. (457 x 508 mm)
Spring Clamp (two sizes)	(3 of each) 6 Total	(5 of each) 10 Total	(7 of each) 14 Total
Spring Post (two sizes)	(3 of each) 6 Total	(5 of each) 10 Total	(7 of each) 14 Total
Extension (three sizes)	(3 of each) 9 Total	(5 of each) 15 Total	(7 of each) 21 Total
Adjustable Extension (two sizes)	(1 of each) 2 Total	(2 of each) 4 Total	(3 of each) 6 Total
Locator Pin (three sizes)	(4 ea, 2 sizes) 8 Total	(5 of each) 15 Total	(7 of each) 21 Total
Radius Locator	4 Total	5 Total	7 Total
Adjustable Base (two sizes)	1 small	(2 sm, 1 lg) 3 Total	(3 sm, 3 lg) 6 Total
Corner Bracket	1 Total	1 Total	1 Total
Plate Locator Kit	1 small	1 small	1 large
Organizer Box	1 small	1 large	1 large
Total Pieces	40 pcs.	65 pcs.	93 pcs.
Price US\$ (+ ship)	\$860	\$1,275	\$1,750

Can be purchased by individual item or by the preconfigured kit



Spring Clamp

Slips over spring post for variable clamping of work-piece.

S SH 025 - Small – 25 mm Length - \$9.00
S SH 055 - Large – 50 mm Length - \$10.00



Spring Post

Used with spring clamp to hold down work-piece. Two (2) lengths (L) available.

S HT M4 000 80 025, L 25 mm, \$13.00
S HT M4 000 80 050, L 50 mm, \$14.00



Locator Pin

Work-piece rests against pin in a stand-off position. Three (3) lengths (L) available.

S HT M4 000 10 005, L 5 mm, \$13.00
S HT M4 000 10 010, L 10 mm, \$14.00
S HT M4 000 10 025, L 20 mm, \$15.00



Radius Locator

Use with base plate or extensions to locate irregular or radius work-pieces.

S HK M4 100 10 007, 5 mm Radius, \$10.00



Adjustable Extension

Provides variable height adjustment.

S VI M4 000 10 022
Adjusts from 22 to 30 mm, \$35.00

S VI M4 000 10 035
Adjusts from 35 to 50 mm, \$38.00



Adjustable Base

Locate all tooling outside of the M4 plate gride to obtain more location flexibility. Two (2) lengths (L) available.

S VS AB M4 010 040, L 40 mm, \$26.00

S VS AB M4 010 060, L 60 mm, \$29.00



Extension

Accepts locator pin, other extensions, and radius locator. Three (3) lengths (L) available.

S VT M4 000 10 010, L 10mm, \$11.00

S VT M4 000 10 020, L 20mm, \$12.00

S VT M4 000 10 215, L 25mm, \$13.00



Corner Bracket

Quick and easy work piece positioning while maintaining clear edge view.

73.0 mm x 73 mm, Contains two M4 thumb screws.

S WS 000 73 19 073, 73 mm, \$40.00



Plate Locator Kit

Secures acrylic plate to table top.

Two (2) Kits available: Large and Small. Includes three (3) sets of: Plate, clamp, M6 and M4 thumb screws.

VLP-Kit SM 150-200, 12 pcs, Small \$160.00

VLP-Kit LG 500, 12 pcs, Large \$160.00

TEMP-COMP

Constant Length at Varying Temperatures

Coordinate Measuring Machines are being introduced directly to the production area, thus reducing and eliminating delays in obtaining corrective values for production machines and making process control more efficient.

However, in order to obtain maximum performance in shop floor measurements, several challenging requirements must be met:

- ↔ **Minimize thermal expansion** to preserve accuracy, especially at high temperature gradients on the manufacturing floor.
- ↔ **High mechanical rigidity**, which has a decisive influence on the accuracy of the measurement
- ↔ **Low weight**, enabling usage of long stylus combinations.

itpstyli manufactures a new generation of carbon fiber **styli** and **extensions** to help obtain accurate measurement in your production area. Engineered to meet the harsh environments of space and aviation, **TEMP-COMP** addresses the thermal expansion, rigidity, and low weight requirements needed to obtain accurate measurements.

Initially developed for aerospace applications, unique carbon fiber materials are used in **TEMP-COMP** styli and extensions. These carbon fibers are coiled at high density, in several layers and directions, which allows for exceptionally high bending and torsion rigidity.

Most importantly, this technology provides a consistent thermal expansion coefficient.

TEMP-COMP products combine **titanium** fittings and a proprietary manufacturing technology that produces a thermally stable and rigid component unmatched in the CMM metrology market.

The following performance data (as illustrated in Table 1) highlights the unique **TEMP-COMP** advantages:

- An E-module of approximately 450 Gpa (Giga-pascal). Compare this to a normal rate of 250 Gpa on other carbon fiber extensions.
- Extremely low thermal expansion coefficients.
- Linear expansion of - 0.00002 mm per degree Kelvin with an extension of 200 mm.
- Linear expansion of + 0.000118 with an extension of 100 mm per degree Kelvin

Table 1: Coefficients of Thermal Expansion for TEMP-COMP Extensions and Styli

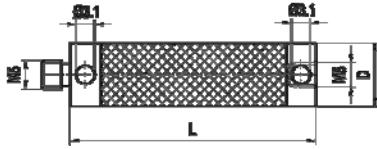
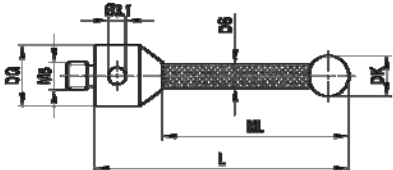
<u>Extensions</u>			
Special carbon fiber body, titanium fittings			
Diameter (D, mm)	Length (L, mm)	Thermal Expansion Coefficient (mm/1°K)	
11	100	0.000148	
11	120	0.000124	
11	150	0.000088	
11	200	0.000028	
20	100	0.000118	
20	150	0.000058	
20	180	0.000002	
20	200	-0.000002	
<u>Styli</u>			
Special carbon fiber stem, titanium fittings			
Stem Diameter DS (mm)	Length L (mm)	Thermal Expansion Coefficient (mm/1°K)	
2	33	0.000057	
2	58	0.000015	
3	53	0.000030	
3.5	53	0.000015	
3.5	75	-0.000003	
4	103	-0.000012	
6	100	-0.000038	

CHOOSE THE MOST SUITABLE MATERIAL FOR YOUR APPLICATION

BEST	Recommended choice (best available)
OK	Acceptable alternative (not ideal)
NO	Not recommended (or not applicable)

THREADED BASE MATERIAL

Thread	STAINLESS STEEL	TITANIUM	ALUMINUM
M2 M3 M4 M6	BEST	OK	NO
M5	OK	BEST	NO

BALL MATERIAL

Application	RUBY	SILICON NITRIDE	CARBIDE	ZYRCONIA
Point-to-Point measurements on all materials	BEST	OK	NO	OK
Scanning on ALUMINUM parts	OK (frequent cleaning required)	BEST	NO	OK
Scanning on CAST IRON	OK (rapid wear)	OK	NO	BEST
Portable CMMs	BEST	NO	NO	OK

STEM or EXTENSION

Application	STAINLESS STEEL	HIGH GRADE STAINLESS STEEL	CARBIDE TUBULAR STEM	CARBIDE FULL STEM	CERAMIC	CARBON FIBER
Point to Point (L < 80)	BEST	OK	OK	OK	OK	OK
Scanning with high stiffness	NO	BEST	OK	OK	OK	NO
Small ball diameters (Ø < 1 mm)	NO	NO	NO	BEST	NO	NO
Reduced weight	NO	NO	NO	NO	OK	BEST
Reduced weight + high stiffness	NO	OK	BEST	OK	OK	NO
Long stylus (L > 150 mm) Ø ball > 4 mm MAX. STIFFNESS	NO	NO	BEST	NO	OK	NO
Long stylus (L > 150 mm) Ø ball < 4 mm MAX. STIFFNESS	NO	NO	NO	BEST	OK	NO
Anticrash	NO	NO	NO	NO	BEST	NO

STEM AND BASE MATERIAL TECHNICAL SPECIFICATIONS

	MATERIAL	HARDNESS	DENSITY
TITANIUM	3.7035 Grade 2	150 Brinell	4.5 g/cm ³
STAINLESS STEEL	1.4035	300 Vickers	7.95 g/cm ³
TUNGSTEN CARBIDE	DK 120	1700 Vickers	15.0 g/cm ³
CERAMIC	Alsint 99.7	9 nach Mohs	3.85 g/cm ³
CARBON FIBER	Bending Strength > 450 GPa CTE (Coefficient of Thermal Expansion) – 0.4x10 ⁻⁶ K ⁻¹		

BALL MATERIAL TECHNICAL SPECIFICATIONS

	RUBY BALLS	CERAMIC BALLS	SILICON NITRIDE BALLS	ZIRCONIA OXIDE BALLS
MATERIAL	Synthetic Ruby Monocrystal Al ₂ O ₃	Aluminum Oxide Polychrystal >99.9 Al ₂ O ₃	Silicon Nitride Polychrystal Si ₃ N ₄	Zirconia Oxide Polychrystal ZrO ₂
FORM DEVIATION	0.08µm - 0.13µm	0.08µm - 0.13µm	0.08µm - 0.13µm	0.08µm - 0.13µm
DIAMETER DEVIATION	0.08µm - 0.13µm	0.08µm - 0.13µm	0.08µm - 0.13µm	0.08µm - 0.13µm
ROUGHNESS Ra	0.007µm - 0.008µm	0.007µm - 0.008µm	0.004µm - 0.005µm	0.007µm - 0.008µm
HARDNESS	2400 Vickers	2100 Vickers	1600 Vickers	1200 Vickers
DENSITY	3.99 g/cm ³	3.85 g/cm ³	3.20 g/cm ³	6.05 g/cm ³
THERMAL EXPANSION	5.4•10 ⁻⁶ K ⁻¹	8.0•10 ⁻⁶ K ⁻¹	2.9•10 ⁻⁶ K ⁻¹	10.5•10 ⁻⁶ K ⁻¹
COMPRESSION STRENGTH (MPa)	2100	3800	3000	2000
BENDING STRENGTH	400	470	>1000	700-1100
FRACTURE TOUGHNESS (MN/m^{3/2})	1	4	>6.5	10

CHOOSING THE RIGHT MATERIAL – BENEFITS AND LIMITATIONS

THREADED BASE	BENEFITS	LIMITATIONS								
Stainless Steel	<ul style="list-style-type: none"> - Very good ratio stiffness/weight - Low wear - Medium-low cost - Always used with M2, M3, and M4 threads. Often used with M5 	<ul style="list-style-type: none"> - Thermal coefficient medium-high 								
Titanium	<ul style="list-style-type: none"> - <u>Best ratio stiffness/weight</u> - Lower thermal coefficient - Minimum wear - Used on some M5 styli - Preferable to Ceramic extension body (slightly higher weight, crash-proof, excellent stiffness) 	<ul style="list-style-type: none"> - Higher cost - More difficult machining 								
STEM / EXTENSION										
Stainless Steel	<ul style="list-style-type: none"> - Very good ratio stiffness/weight - Reduced cost - Good for diameters over 0.7 mm - Perfect electrical conductivity <table style="margin-left: auto; margin-right: auto;"> <tr> <td style="text-align: center;">Stem diameter</td> <td style="text-align: center;">Max length</td> </tr> <tr> <td style="text-align: center;">0.7 - 1</td> <td style="text-align: center;">20</td> </tr> <tr> <td style="text-align: center;">1.5 - 3</td> <td style="text-align: center;">40</td> </tr> <tr> <td style="text-align: center;">4 - 6</td> <td style="text-align: center;">80</td> </tr> </table>	Stem diameter	Max length	0.7 - 1	20	1.5 - 3	40	4 - 6	80	<ul style="list-style-type: none"> - Under 0.7 mm diameter, the stem bending is not acceptable
Stem diameter	Max length									
0.7 - 1	20									
1.5 - 3	40									
4 - 6	80									
High Grade Stainless Steel (used in Aerospace industry) high stiffness	<ul style="list-style-type: none"> - <u>Base and stem machined from one single steel part (integral)</u> - Higher stiffness - Better ratio stiffness/weight - <u>Ideal for scanning (M5)</u> 	<ul style="list-style-type: none"> - Higher cost - Available only for M5 range 								
Tungsten Carbide solid stem	<ul style="list-style-type: none"> - <u>Best stiffness vs. metal stems</u> - Necessary for diameters under 0.7 mm. - <u>Necessary for balls under 1 mm diameter</u> 	<ul style="list-style-type: none"> - Highest density = highest weight for same diameter and length - Higher cost vs. stainless steel 								
Tungsten Carbide tube stem	<ul style="list-style-type: none"> - <u>Lighter than solid carbide stem for same diameter</u> - Lengths from 50 to 118 mm - Ball size from 5 to 10 mm - Ideal for lengths over 80 mm 	<ul style="list-style-type: none"> - Not available for ball diameters smaller than 5 mm - Higher cost - Available only for M5 - Adhered ball 								
STEM / EXTENSION										
Standard Carbon Fiber	<ul style="list-style-type: none"> - Low weight and resistant to crashes - Minimal thermal coefficient - Good for styli over 100 mm lengths with stem size over 6 mm - Ideal for extensions over 200 mm <table style="margin-left: auto; margin-right: auto;"> <tr> <td style="text-align: center;">stem length</td> <td style="text-align: center;">diameter</td> </tr> <tr> <td style="text-align: center;">20 – 40</td> <td style="text-align: center;">3</td> </tr> <tr> <td style="text-align: center;">40 – 70</td> <td style="text-align: center;">4</td> </tr> <tr> <td style="text-align: center;">75 – 100</td> <td style="text-align: center;">8</td> </tr> </table>	stem length	diameter	20 – 40	3	40 – 70	4	75 – 100	8	<ul style="list-style-type: none"> - Lower stiffness vs. ceramic - Not to be used for stems under 3 mm diameter - Higher cost
stem length	diameter									
20 – 40	3									
40 – 70	4									
75 – 100	8									

CHOOSING THE RIGHT MATERIAL – BENEFITS AND LIMITATIONS

<p>TEMP-COMP Carbon Fiber (new)</p>	<ul style="list-style-type: none"> - <u>Best absolute ratio stiffness / weight (E-module > 450 GPa)</u> - <u>The lowest total thermal coefficient (body + base or fittings) due to mutual compensation between metal and fiber parts (negative coefficient of the fiber, positive of the base/fittings)</u> - Used on high-end CMMs used on shop floor <table style="margin-left: auto; margin-right: auto; border: none;"> <tr> <td style="padding: 0 10px;">stem length</td> <td style="padding: 0 10px;">diameter</td> </tr> <tr> <td style="padding: 0 10px;">20 – 40</td> <td style="padding: 0 10px;">2</td> </tr> <tr> <td style="padding: 0 10px;">40 – 80</td> <td style="padding: 0 10px;">3.5</td> </tr> <tr> <td style="padding: 0 10px;">90 – 100</td> <td style="padding: 0 10px;">6</td> </tr> </table>	stem length	diameter	20 – 40	2	40 – 80	3.5	90 – 100	6	<ul style="list-style-type: none"> - Higher cost than traditional Carbon Fiber - Stem diameters are available in sizes 2 mm and above - Extension diameters are 11 mm and 20 mm only
stem length	diameter									
20 – 40	2									
40 – 80	3.5									
90 – 100	6									
<p style="text-align: center;">Ceramic</p>	<ul style="list-style-type: none"> - Low weight - Best stiffness for same weight and diameter size - Low thermal coefficient - Good for styli over 100 mm lengths with stem size over 4 mm - <u>Ideal for protection of probe head against crashes (e. g. CNC machining centres)</u> - Adhered balls with stem size over 3.5 mm - Drilled balls for stems under 3.5 mm 	<ul style="list-style-type: none"> - Fragile - <u>Not to be used under 2 mm stem size</u> 								
<p style="text-align: center;">BALL MATERIAL</p>										
<p>Ruby (AL₂O₃ / Cr₂O₃)</p>	<ul style="list-style-type: none"> - <u>Best ratio features/price</u> - Diamond-like hardness (9 for Ruby, 10 for diamond on Mohs scale) - Very high roundness/roughness features for very small sizes (down to 0.3 mm) - Excellent resistance to wear - Ideal for point to point and scanning on steel parts 	<ul style="list-style-type: none"> - <u>Attracts Aluminum particles for continuous scanning applications (heavy and repeated cleaning procedures)</u> - Available sizes up to 13 mm 								
<p>Silicon Nitride (Si₃N₄)</p>	<ul style="list-style-type: none"> - Smoother surface (lower friction) - <u>Ideal for scanning on Aluminum parts (no build up of material particles)</u> 	<ul style="list-style-type: none"> - Higher cost - Diameters sizes limited (from 1 to 10 mm only as standard, larger diameters are possible under request) 								
<p style="text-align: center;">Tungsten Carbide</p>	<ul style="list-style-type: none"> - Low weight - Possible to obtain the ball from stem machining - Better shock absorption - Normally used on articulated arms 	<ul style="list-style-type: none"> - Surface and dimensional features lower than Ruby - rapid loss of dimensional tolerances - very low roundness and roughness for ball sizes under 1 mm diameter 								
<p>Zirconium Oxide (Zr O₂)</p>	<ul style="list-style-type: none"> - Very good surface features (comparable to Ruby) - <u>Ideal for scanning on Cast Iron parts (lower friction, lower wear)</u> 	<ul style="list-style-type: none"> - Higher cost than ruby 								



Design Your Own Custom Stylus

The extensive **itpstyli** product line will address many of your application needs, but not all of them. As such, **itpstyli** has developed business and manufacturing processes to make it easy and affordable for you to design and receive your custom stylus.

Your design will fall into one of two categories: special or exotic. A special design is a unique configuration that utilizes standard components, such as M2 thread, titanium base, ceramic stem and a ruby ball. The dimensional requirements and combination of materials are what make it special.

An exotic design is one that has a component or feature that cannot be found in our catalog, such as a 0.2 mm ruby ball attached to a 7 mm stem and base.

Custom styli cost and turnaround time:

- *Special* styli will ship within 72 hours from receipt of order, and your cost will be reasonably similar to that of the closest item that we offer in our standard line.
- *Exotic* styli, which require more time to estimate manufacturing cost and delivery time, will be quoted within 48 hours.

THREAD SIZE GUIDE FOR PROBE HEADS

M2	M3	M4		M5	M6
MH20i	MIP	CYCLONE	MP16	LEITZ TRAX	FARO
P1-5A	SP25	CP1	MP18	DT	
P1-5BS	SP25M	DEA TF8	MP700	LSP-X3	
TP2	TESA	LP2	MP700E	LSP-X5	
TP20	TESASTAR	LP2DD	OMP40	RST-P	
TP200	TP1	LP2H	RMP60	SiP-3D	
TP200B	TP1SM	MP1	RP1	SP2	
TP200 NI	TP-50	MP3	RP1DD	SP2-1	
	TP6	MP4	RP2	SP80	
	TP6A	MP6	RP2DD	ST2	
	TPES	MP7	RP3	ST3	
	VAST XXT	MP8	SP600	UNIVERSAL 3D	
		MP9	SP600M	VAST GOLD	
		MP10	SP620	VAST NAVIGATOR	
		MP10E	TP7	VAST XT	
		MP11	TP7M	ZEISS	
		MP12	TP800		
		MP15	TS27R		

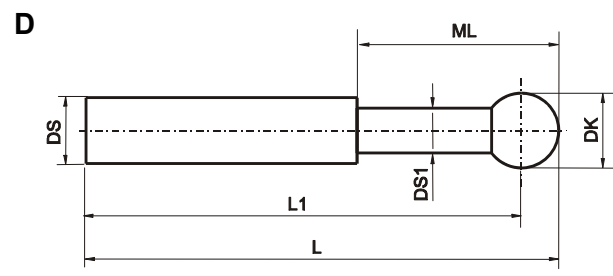
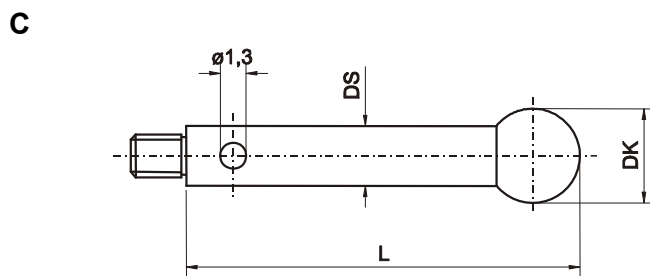
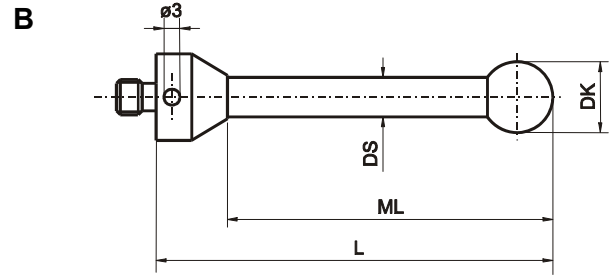
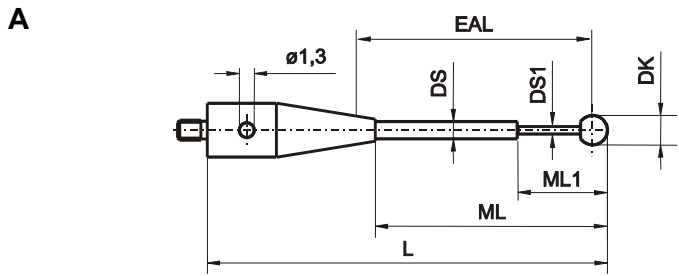

Styli Type (A-B-C-D)	<input type="text"/>	<input type="text"/>	<input type="text"/>	<input type="text"/>
Thread (M2, 3, 4, 5, or none)	<u>M</u> <input type="text"/>	<u>M</u> <input type="text"/>	<u>M</u> <input type="text"/>	<u>M</u> <input type="text"/>
Ball Material – Ruby (R) Silicon (S) Ceramic (C) Zirconia (Z)	<input type="text"/>	<input type="text"/>	<input type="text"/>	<input type="text"/>
Ball Diameter (mm) – DK	<input type="text"/>	<input type="text"/>	<input type="text"/>	<input type="text"/>
Measure length (mm) – ML	<input type="text"/>	<input type="text"/>	<input type="text"/>	<input type="text"/>
Total length (mm) – L	<input type="text"/>	<input type="text"/>	<input type="text"/>	<input type="text"/>
Stem Diameter (mm) – DS, DS1 (if required)	<input type="text"/>	<input type="text"/>	<input type="text"/>	<input type="text"/>
Stem Material	<input type="text"/>	<input type="text"/>	<input type="text"/>	<input type="text"/>
Stainless Steel	<input type="text"/>	<input type="text"/>	<input type="text"/>	<input type="text"/>
Carbide	<input type="text"/>	<input type="text"/>	<input type="text"/>	<input type="text"/>
Ceramic	<input type="text"/>	<input type="text"/>	<input type="text"/>	<input type="text"/>
Temp-Comp Carbon Fiber	<input type="text"/>	<input type="text"/>	<input type="text"/>	<input type="text"/>
Quantity	<input type="text"/>	<input type="text"/>	<input type="text"/>	<input type="text"/>
Name:	<input type="text"/>	Phone:	<input type="text"/>	
Company:	<input type="text"/>	Fax:	<input type="text"/>	
Email:	<input type="text"/>			

RETURN FAX 314-432-3107

You may also request a quote at itpstyli.com by following the link to Design Your Own.

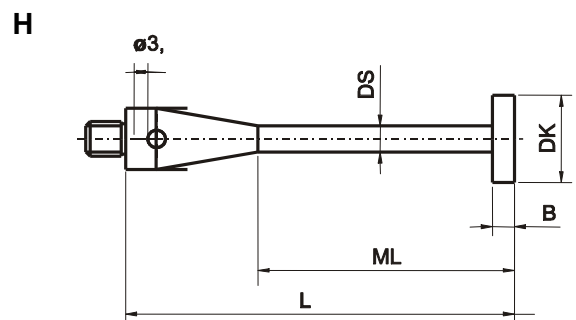
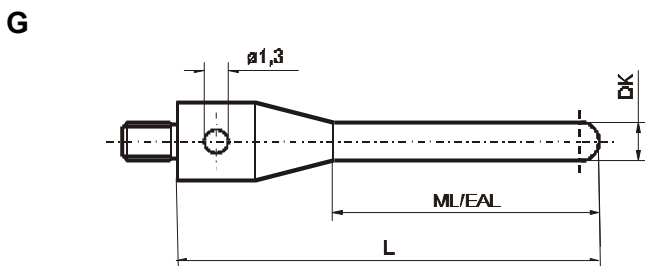
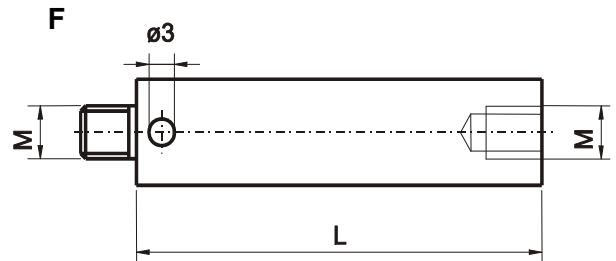
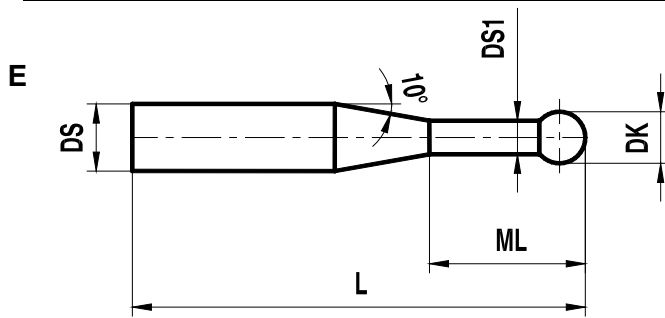

Styli Type (E-F-G-H)				
Thread (M2, 3, 4, 5 or none)	<u>M</u> <input type="text"/>	<u>M</u> <input type="text"/>	<u>M</u> <input type="text"/>	<u>M</u> <input type="text"/>
Ball Material – Ruby (R) Silicone (S) Ceramic (C) Carbide (CB) Zirconia (Z)				
Ball Diameter (mm) – DK				
Measure length (mm) – ML				
Total length (mm) – L				
Stem Diameter (mm) – DS, DS1 (if required)				
Stem Material				
Stainless Steel				
Carbide				
Ceramic				
Temp-Comp Carbon Fiber				
Quantity	<input type="text"/>	<input type="text"/>	<input type="text"/>	<input type="text"/>
Name:	<input type="text"/>	Phone:	<input type="text"/>	
Company:	<input type="text"/>	Fax:	<input type="text"/>	
Email:	<input type="text"/>			

RETURN FAX 314-432-3107

You may also request a quote at itpstyli.com by following the link to Design Your Own.



Order Form

Please copy, complete and return via fax or mail.

BILL TO:

Name:	
Company:	
Address:	
Address:	
City, State Zip:	
Phone:	
Fax:	E-mail:

SHIP TO:

Name:	
Company:	
Address:	
Address:	
City, State Zip:	
Phone:	
Fax:	

P.O. Number (required) _____

itp Item Number	Quantity	Cost Each	Total

Select Shipping Charge: Surface \$9.00 ___ Second Day Air: \$19.00 ___ Next Day: \$33.00 ___

Credit Cards Accepted - Please call if you would like to use MasterCard or Visa.

Sub-total	
Tax	
Shipping	
TOTAL	

RETURN FAX 314-432-3107



Quick Reference Conversion Chart

TO CONVERT **inch TO mm:**

MULTIPLY INCHES by 25.4

TO CONVERT **mm TO inch:**

MULTIPLY mm by 0.03937
OR
DIVIDE mm BY 25.4

inch	inch	mm
1/64	0.016	0.397
1/32	0.031	0.794
3/64	0.047	1.191
1/16	0.063	1.588
5/64	0.078	1.984
3/32	0.094	2.381
7/64	0.109	2.778
1/8	0.125	3.175
9/64	0.141	3.572
5/32	0.156	3.969
11/64	0.172	4.366
3/16	0.188	4.763
13/64	0.203	5.159
7/32	0.219	5.556
15/64	0.234	5.953
1/4	0.250	6.35
17/64	0.266	6.747
9/32	0.281	7.144
19/64	0.297	7.541
5/16	0.313	7.938
21/64	0.328	8.334
11/32	0.344	8.731
23/64	0.359	9.128
3/8	0.375	9.525
25/64	0.391	9.922
13/32	0.406	10.319
27/64	0.422	10.716
7/16	0.438	11.113
29/64	0.453	11.509
15/32	0.469	11.906
31/64	0.484	12.303

inch	inch	mm
1/2	0.500	12.7
33/64	0.516	13.097
17/32	0.531	13.494
35/64	0.547	13.891
9/16	0.563	14.288
37/64	0.578	14.684
19/32	0.594	15.081
39/64	0.609	15.478
5/8	0.625	15.875
41/64	0.641	16.272
21/32	0.656	16.669
43/64	0.672	17.066
11/16	0.688	17.463
45/64	0.703	17.859
23/32	0.719	18.256
3/4	0.750	19.05
49/64	0.766	19.447
25/32	0.781	19.844
51/64	0.797	20.241
13/16	0.813	20.638
27/32	0.844	21.431
55/64	0.859	21.828
7/8	0.875	22.225
57/64	0.891	22.622
29/32	0.906	23.019
59/64	0.922	23.416
15/16	0.938	23.813
61/64	0.953	24.209
31/32	0.969	24.606
63/64	0.984	25.003
1	1.000	25.4

mm	inch
0.3	0.012
0.5	0.020
0.8	0.031
1.0	0.039
1.5	0.059
2.0	0.079
2.5	0.098
3.0	0.118
3.5	0.138
4.0	0.157
4.5	0.177
5.0	0.197
5.5	0.217
6.0	0.236
6.5	0.256
7.0	0.276
7.5	0.295
8.0	0.315
8.5	0.335
9.0	0.354
9.5	0.374
10.0	0.394
10.5	0.413
11.0	0.433
11.5	0.453
12.0	0.472
12.5	0.492
13.0	0.512
13.5	0.531
14.0	0.551
14.5	0.571

